

Article number: 437900040

Description: Rota-fix shaft-hub connection SA 40

Measures

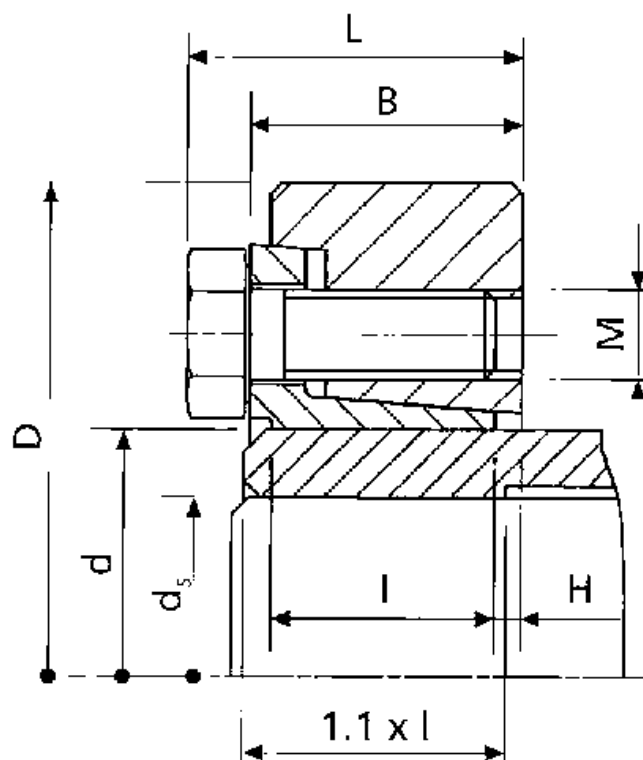

B mm	= 24.0	M mm	= M8
d H8 mm	= 40	T N m torque	= 880
D mm	= 80.0	Ts N m bolt tightening torque	= 30
ds mm	= 34		
F kN torque	= 52		
H	= 2.0		
I mm	= 20.5		
L mm	= 29.5		